

User's Manual 2008

Power Commander IQ

Network Controlled

SPDU8-1U, SPDU16-2U, SPDU20-0U

Wiremold/Legrand® electrical systems conform to and should be properly grounded in compliance with requirements of the current National Electrical Code or codes administered by local authorities. All electrical products may present a possible shock or fire hazard if improperly installed or used. Wiremold/Legrand electrical products may bear the mark as UL Listed and/or Classified and should be installed in conformance with current local and/or the National Electrical Code.

Copyright Notice

Copyright© 2008 by Wiremold/Legrand. The material discussed in this manual is the proprietary property of Wiremold/Legrand. All retains all rights to reproduction and distribution of this document.

FCC Warning

The Federal Communications Commission has set limits for emitted radio interference. The Wiremold / Legrand. systems are constructed with this electromagnetic interference (EMI) limitation in mind. The systems are classified under FCC Regulations as a Class A and Class B device. A Class A device may be used in commercial environments and not in residential areas, while a Class B device may be used in commercial environments residential areas. The Power Commender IQ series devices has been tested and shown to comply with the following FCC rule: Part 15 Subpart J and ICES-003.

UL Safety Standards Compliance

Power Commender IQ Series products have been tested and found to be accordance with the following listed test requirements:

UL-60950-1: 2003, R7.06

CAN/CSA-C22.2 No. 60950-1-03

Warranty Information:

The warranty period on this product (parts and labor) is one (2) year from the date of purchase. Please contact Wiremold / Legrand at 1-800-621-0049 or visit our website at www.wiremold.com for information regarding repairs and/or returns. A return authorization number is required for all repairs/returns. See Appendix A for more information.

Changes:

The material in this guide is for information only and is subject to change without notice. Wiremold / Legrand reserves the rights to make changes in the product design without reservation and without notification to its users.

Wiremold / Legrand

U.S. and International:

60 Woodlawn Street • West Hartford, CT 06110

1-800-621-0049 • FAX 860-232-2062 •

Outside U.S. 860-233-6251

Canada:

570 Applewood Crescent • Vaughan, Ontario L4K 4B4

1-800-723-5175 • FAX 905-738-9721

TABLE OF CONTENTS

1 SYSTEM DESCRIPTION	1
1.1 Products comparison chart:	1
1.2 What you can do with the system:	1
1.3 Front and back panel:	2
2 IMPORTANT SAFETY PRECAUTIONS FOR HARDWARE INSTALLATION	3
2.1 Safety precautions	3
2.2 Battery replacement	3
3 ACCESS TO THE SYSTEM	3
3.1 Factory default settings:	3
3.2 User privileges and port reservations:	4
3.3 Local master port access:	4
3.4 External modem access:	4
3.5 Telnet access:	4
3.6 Web access:	5
3.7 Email access:	5
3.8 SNMP information:	5
3.9 AutoPing and power reboot:	7
4 USING CONTROL COMMAND	7
5 USING CONFIGURATION MENU	8
5.1 Starting configuration menu:	8
5.2 System main menu:	8
5.3 System access setup menu:	10
5.4 TCP/IP network configuration menu:	12
5.5 More about emailing access:	12
5.5.1 Sending Control command to the system:	12
5.6 Serial console port configuration menu:	12
5.7 Power outlet setup menu:	13
5.8 User account management menu:	16
5.9 Viewing and changing operation status with a web page:	16
APPENDIX A WARRANTY INFORMATION	17
APPENDIX B SERIAL CONSOLE PORT INTERFACES	18
APPENDIX C RS-232 TO RJ45 CONVERSION CABLES	18

1 SYSTEM DESCRIPTION

1.1 Products Comparison Chart:

POWER COMMANDER IQ								
Model	Chassis	# of Outlets	# of Input Power Cords (Inlet)	Total AC Current Output Amps	Input Power Cord Plug Type	AC Current Monitoring	Network Port (Ethernet)	Regulatory UL Safety & EMI
SPDU8	1-U	8	1	15	NEMA 5-15P	Y	Y	UL60950-1/FCC Class A
SPDU16	2-U	16	2	30	NEMA 5-15P	Y	Y	UL/FCC Class A
SPDU20	0-U Vertical	20	1	20	NEMA L5-20P	Y	Y	UL/FCC Class A

Figure 1 - Product Comparison Chart

The above listed systems provide secure and versatile power reboot management access for communication equipment such as routers, switches, and network devices. They are also the ideal assistant devices for engineering development and test applications. Key features include:

- **Local Master Port access:** offers data rates from 2400 to 115200 bits/second and optional hardware handshaking (CTS/RTS). There are two operation modes for the port: Console Transparent Mode and System Control Mode.
- **Three user privilege login levels:** The Administration level manages system configuration and unconditional access to all power outlets and all serial ports. The User level allows each user to reserve and manage his/her own ports, as well as to change most of system configuration settings. Anonymous users are able to view all settings and operate unreserved power outlets and serial console ports.
- **User name and password for each port:** Each port is user name and password protected.
- **Line commands or menu configuration controls:** Menu table operation offers user-friendly operation methods that are used for changing system configurations, viewing run time statuses, and issuing controls. Line commands provide quick and easy operations.
- **Telnet access:** Remote access the system over a TCP/IP network for configuration and control of the systems.
- **Out of band Modem access interfacing:** Control and configure the system via a telephone line. Optional custom Modem AT command string to the Modem.
- **HTTP web access:** Embedded web server provides secured user name and password authentication. The operations are easy and friendly, utilizing tables and graphical icons. Download SNMP MIB files for convenience, or view an online help manual.

- **SNMP MIB capability:** An **SNMP (Simple Network Management Protocol)** agent is integrated in the system for an exchange of management information between the system and network devices.
- **POP/SMTP Emailing with SMTP Authentication capability:** A user can send control commands such as reboot power outlet via emails. Command execution reports are replied for each command email received. SMTP user name and password are protected through authentication process.
- **SNMP Trap for sending logging message:** The **Trap** is used to asynchronously report events to the NMS. It forwards power reboot command execution information to the remote Trap logging receiver.

1.2 What you can do with the system:

- **Remote equipment power source management over TCP/IP networks,** including rebooting user equipment, and permanently turning on/off user power source. Schedule power reboots or power source on/off events monthly, weekly, daily or at any time an application requires. Reboot power source to equipment when a network connection is lost.
- **Monitoring AC Power Consumptions** and sending warning messages when the aggregated AC draw from a system is crossed predefined threshold.
- **Remote control anywhere by emailing.** Via emails, you are able to manage the systems or user communication equipment power sources when LAN access is impossible. Via emails, you can send user data to the NP control commands such as rebooting user power source. Reply emails are sent after the system intercepts incoming emails so that you are informed with the operation status.
- **AutoPing and reboot user equipment.** Connect your system to a power outlet and assign the system network IP address or URL. The NP system will ping the user equipment periodically (in every 15 seconds). If the user

equipment stops responding the ping request, the equipment will be power rebooted.

- **Scheduling AC outlet power cycling periodically or per weekly planner.** Each outlet can be programmed with it's own timer.

1.3 Front and Back Panel:



Figure 3 - SPDU8-1U Front and Back Panel Illustration



Figure 4 - SPDU8-1U Detail of Connections



Figure 5 - SPDU16-2U Front and Back Panel Illustration



Figure 5A - SPDU20-0U Front and Back Panel Illustration

1. **Power Outlet status LEDs:** Visual indication of user power outlet On/Off status.
2. **NP system power On/Off status LED:** Indication of system power On/Off status.
3. **Ethernet Link status LED:** When the LED is illuminated, Ethernet port and a LAN connection are established.
4. **Ethernet Active data status LED:** When there is data traffic on the LAN, the LED is illuminated.
5. **Factory Default Reset switch:** Allow a user to reset the system to factory default settings. The switch is located behind the small front panel opening.
6. **Power Outlet sockets:** Power outlets for user applications.
7. **Local Master Port** (DCE, 9 pin DB, female, or RJ-45 socket): This is also a service port for the user to configure and change system operation settings.
8. **Ethernet Port** (RJ45, 10 base-T): 10 based-T Ethernet port for connection to LAN.
9. **Manual Switch:** Outlet power output switch. Momentarily pressing down the button to index to the desired outlet. Pressing down for 3 seconds to toggle the outlet power state. This switch is equipped on NP08 and NP-16 systems.
10. **Audio Alarm Off Switch:** To temporarily turn off the audio alarm when aggregated AC current draw crosses over the defined threshold. This control switch is equipped on NPB-20 system.

2 IMPORTANT SAFETY PRECAUTIONS FOR HARDWARE INSTALLATION

2.1 Safety Precautions

It is important that you read this section before attempting any of the hardware installation and maintenance procedures in this guide.

The following instructions are important for your safety and for the functioning of the unit. Read the instructions carefully before attempting the installation

WARNING! To reduce the risk of fire or electrical shock, never remove the cover of the unit. No user serviceable parts inside. Repair should be done by authorized service personnel only.

The unit should be installed in indoor with ambient temperature and sufficient airflow.

WARNING! Ensure that the hardware you are working with is disconnected from the power supply during installation. This means that the unit's power cable and network cables must remain disconnected until you are instructed to make the connections. Follow the instructions in the procedures carefully.

This equipment is disconnected from the power supply by removing the power cord(s) from the power outlet. It is therefore important to locate the unit close to a power outlet that is easily accessible.

WARNING! When connecting a hardware unit to a power supply, for your safety you must always connect it to a grounded wall outlet.

2.2 Battery Replacement

A 3.0V Lithium battery is installed in the unit for internal Real-Time Clock and system data retention. The battery should last at least 10 years. If the battery needs to be replaced, please ask qualified personnel for the service. Here is the instruction for the replacement:

- A) Use CR2032 type, 3.0V Lithium battery.
- B) Remove the old battery from the battery holder,
- C) Insert the new replacement to the holder with "+" facing up.

3 ACCESS TO THE SYSTEM

3.1 Factory Default Settings:

The system is shipped with Factory Default settings. The default settings for the Local Master serial port are: **9600, 8 data bits, no parity, 1 stop bit, and no hardware handshaking (Flow Control)**. The default Administrator's login name "admin" and the default password is "admin". All existing user accounts are erased if the system is recovered to the default settings. The default SNMP Community string for public, private and Trap access is "public".

There are two ways to restore the system to the Factory Default settings. The first method is to press a push-button switch located on the front panel for 1 second. The second method

is to select "Reload Factory Defaults" from the Main Menu. The Main Menu can be viewed by running a terminal emulation program such as Window's Hyper Terminal or Telnet.

Upon the system startup, the terminal screen displays the following screen, as shown in the Figure 6.

If you do not see the screen as shown in the Figure 6, it is likely that the system is not in the default state. Otherwise, your connection to the Local Master port is established.

3.2 User Privileges and Port Reservations:

All user levels, including anonymous (visitor), are able to access the system via a serial connection from your work station to the Local Master port, or via a Telnet session from your work station.

- **Administration Login:** There is only one Administration account on the system. The default name is “admin” and default password is also “admin”. The default name and password may be changed. If you login at Administration level, you are able to remove or change existing user accounts, take over power outlets or user serial console ports and change system settings.
- **User Login:** At user login level, you are able to reserve power or console ports for your applications if they are “open”, as well as make system configuration changes. At this login level, you are not able to change power outlet operation status for other reserved power outlets.
- **Anonymous(Visitor) Access:** If you have no account established on the system (as an anonymous user), you are only able to view the system configuration settings and operate unreserved power outlets.

3.3 Local Master Port Access:

To access and configure the system from the master port, you need to connect a RS232 port from your work station to the Local Master Serial Port. Then run a terminal emulation program (such as Window’s Hyper Terminal) on your computer.

- 1) Connect the system’s Local Master Port (DCE) with a straight DB-9 type cable, if your work station is equipped with a DTE part.
- 2) Connect the system’s Ethernet port to your LAN, if you intend to use the network port.
- 3) Turn the system power on.
- 4) At the terminal emulation program, type the “setup” command to start the system setup process. Type “help” for help information.
- 5) The system has DHCP enabled, as a default setting. Network connectivity parameters are displayed at the startup screen. If the system does not get a DHCP offer, the system falls back to default static network settings. You can alter the default network settings to fit your need.
- 6) Use the command “ping” to verify your connection. If a network connection is established, you are able to use Telnet, Web Browsing, Emailing and SNMP.

3.4 External Modem Access:

With this access method, an RS232 port on an external Modem device is connected to the Local Master Port. Typically, a Modem device is equipped with a DCE (Data Communication Equipment) terminal connector. Since the system’s Local Master Port and Modem device ports are not complementary (both are DCE ports); you need to use a NULL Modem cable with both male connectors.

3.5 Telnet Access:

Operation of on a Telnet terminal is almost identical to the access method via Local Master Serial Port. You need to make sure that Telnet access is enabled, as a default setting. If the access is not enabled, please refer to Section “Using Configuration Menu” to change the setting.

Before you start the Telnet application, you need to obtain the actual IP address for the system. The system displays network connectivity information at system startup terminal when your workstation is connected to the system’s Local Master Serial Port. Please refer to “TCP/IP Network Configuration” section of this document for information on how to setup the network parameters.

Once the network connection is established, at your workstation prompt, you need to enter:

telnet ip_addr

You need to set a Telnet session on your workstation to Local Echo Off mode.

Telnet session permits an anonymous user who may only to view the system settings and operate unreserved power outlets and user serial console ports. Please refer to section 2.2 “User privileges and Port Reservations” for further information.

- Only one Telnet session may be active at the time. Telnet sessions will be refused by the system if it already has a Telnet session active.
- A Telnet session remains active for 10 minutes if it is in idle state.
- Telnet access methods can be enabled or disabled using the System Access Setup Menu.
- To terminate an active Telnet session, use the command “logout” at the terminal. If you are at a serial port terminal and notice that the terminal is disabled because it is taken over by a remote Telnet session, use the command “telnetend” at the serial console terminal to terminate the Telnet if you need to do so.

3.6 Web Access:

You need to obtain the system IP address before starting web access to the system. Please refer to the Telnet Access section for methods to get the system IP address. You also need to make sure that web access is enabled, as a default setting. If the access is not enabled, please refer to Section “Using Configuration Menu” to change the setting. Start a Web browsing application program such as Window’s Explorer and enter “http://ip_address“in the address field.

You must have an account on the system in order to access the system via this method. Without a valid account, you are only able to view the following web page and get a copy of the Help text message.

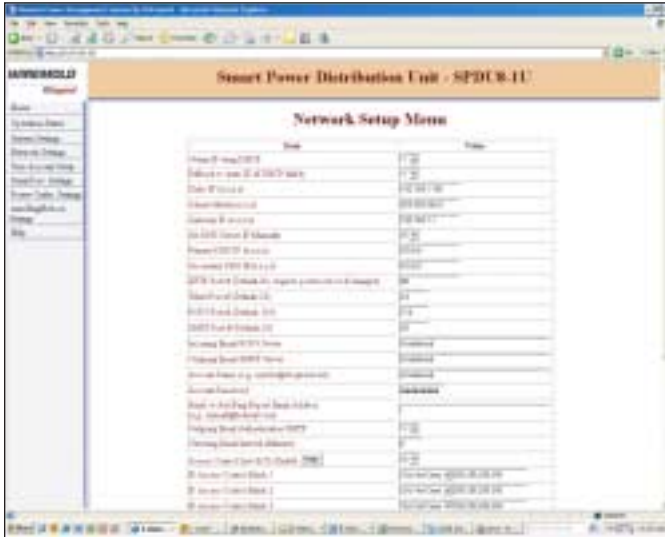

Figure 9 - Web Access Startup Page (NP-08)

Upon clicking the Login button, a secured login table is displayed at your work station, shown as in the Figure 10. Factory default setting for user name is “admin”. The default password is “admin”.



Figure 10 - Web Access Login Entry Table

3.7 Email Access:

To establish this access method, the system’s network connection is already established. With the email access method, you are able to execute the NP system controlling mails commands. The NP system periodically checks incoming mails from a designated POP mail server. The system sends a reply email with command process status if an email is intercepted. See Section 4.4 for more information about how to setup email accounts.

3.8 SNMP Information:

Applications such as an NMS (Network Management System) or an SNMP browser can exchange information with the NP systems. SNMP is disabled with the default setting.

The information managed by an SNMP daemon on the system can be obtained using SNMP requests from a remote work station. An SNMP Get/Get Next request fetches the value of a single variable or a set of variables. An SNMP Set request modifies the value of a variable.

You need to know the name of a variable before your can fetch or modify a variable’s value. A variable’s symbolic name is mapped to a numeric name, which is referred as OID.

The MIB (Management Information Base) is a text file describing the internal objects the SNMP agent can display, monitor, and/or modify. Each MIB object is the system variable that has name and an OID, as shown in Figure 12. You need the MIB file to properly configure the SNMP client (“manager”) for server monitoring. To get a copy of the MIB file, please use a web browser to access the NP systems. Open the TCP/IP Network Configuration Menu and then click the button “Get SNMP MIB File” to download the MIB file that is stored in the system’s memory.

ENTERPRISE OID: 1.3.6.1.4.1.21728.2.4.1		
DEFINITION	OID	RETURNED MESSAGE
systemModel	.1.1	System Model number. Read only.
systemName	.1.2	The system name or site name. Read only.
powerOutletNum	.1.3	Number of power outlets on the system. Read only.
serialPortNum	.1.4	Number of console ports on the system. Read only.
systemUpTime	.1.5	Seconds since the system in operation.
swVersion	.1.6	Firmware version
Outlet Sequence		
outletIndex	.2.1	Index for the outlet table
outletName	.2.2	Outlet socket name. Read/Write.
outletStatus	.2.3	Outlet socket ON/OFF status. Read only.
outletAction	.3.4	Change outlet state to ON, OFF or Reboot. Write only.
powerOutlet4OpStatus	.3.2.5.0	Read/Write. Applicable to NPC/NP systems.
Envro/Current Sequence		
enviroIndex	.3.1	Index for the table
currentAlarmThreshold	.3.2	Aggregated AC current draw threshold for each power inlet (or power cord).
currentDrawStatus1	.3.3	First AC current monitoring reading. For a system equipped with single power cord, this the valid current reading. For dual power corded system, this is the first part of the AC current reading.
CurrentDrawStatus2	.3.4	For dual power corded system, this is the AC current reading for the second power inlet (or power cord).
currentDrawMax1	.3.5	Maximum aggregated AC current draw value was captured for the first power inlet (or power cord). For a system equipped with single power cord, this is the valid current reading. For dual power corded system, this is the first part of the AC current reading.
CurrentDrawMax2	.3.5	Maximum aggregated AC current draw value was captured for the 2nd power inlet (or power cord).
temperatureThreshold	.3.6	Environment temperature threshold in F.
temperatureReading	.3.7	Temperature reading in F. Value is zero when the temperature probe is not installed.
Event Notifications		
opEvents	.100.1	Explicit operation events. Last TRAP/Notification sent. The messages include outlet power status changes, AutoPing/Reboot events, system power on event, user login/logout event,
CurrentThresholdCross-Event	.100.2	Current draw (Amps) crosses the defined threshold for inlet 1 or 2."
temperatureThresholdCrossEvent	.100.3	Environment temperature reading (in F) crosses predefined threshold.

Figure 12 - Implemented MIB Description, List of MIB object

3.9 AutoPing and Power Reboot:

Each power outlet has optional settings that a NP system uses to ping network equipment. The pinged equipment is attached to a specific power outlet. It reboots user equipment power source if a network connection is not detected any more. However, user equipment never gets power reboot if the equipment never replies ping reply to a NP system.

A power outlet has the optional settings (Power Outlet Setup Menu) that specify the destination IP address that the system

will ping periodically, and maximum network downtime allowed. In addition, to avoid unwanted reboots, a NP system also pings the gateway IP address (as default) to make sure a NP system has a network connection that is still active. Otherwise, AutoPing will be in off mode if a NP system lost network connection. To change the default gateway IP address as ping destination, use TCP/IP Configuration Menu to enter your desired destination address.

4 USING CONTROL COMMAND

A NP system provides command line options for viewing or changing system configuration and operation status. In addition, by using the control command option, users are able to create script files for automation of equipment test and control.

Control commands are applicable to the connections between your work station and Local Master Serial Port or a Telnet session.

Some of the control commands are also applicable to emails. See related sections for more detailed information about how to setup email accounts.

Once the system starts or a Telnet session is open, you are ready to send control command to the system. Type command "help" to have a complete list of available commands, as shown in Figure 13.

All login levels including anonymous users are able to use the command line option. However, the actual command executions are based on your login level. For example, if you are an anonymous user, you are not able to reserve or un-reserve serial console ports or power outlets. If you login at Administration level, you are able to operate any serial ports and power outlets, reserve or unreserved any ports or outlets even if they are reserved by other users. See Section 2.2 for a complete description of user privileges.

```
*****
*                               *
*   Help Menu                   *
*                               *
*****
>
ap/vbs n Displays AutoPing run          -timeinfo(0   -disabl e,1 -enable)
cs n    Displays AC current draw Status(1 -display,0 -erasemaxvalue) .
date    Displays current date
email/vbs n Displays emailing runtime info(0 -disable,1 -basic,2 -detailed)
emailget Starts email reading immediately
emails end Sends a test email message immediately
ecmd    Sets email command delimiter (Select: &, -, +, -, $, *, >, |, <, @)
ftpget ip id pwd fileName              - Get system data file from a FTP server.
ftpput ip id pwd fileName              - Put system data file to a FTP server.
login   *Enters user login
logout  *Exits current login
datalog Executes data logging(0 -loggingoff;1 - on; 2 -read;3 -clear)
mac     Displays Ethernet port Mac address
nwset   Restarts Ethernet network interface
nwshow  Displays network Status
ping    *Pings a host. E.g.: ping 192.168.0.1, or ping yahoo.com
prsv n  *Reserves power outlet #n for current login user
psset n v *Sets power outlet #n to v(value 1 -on, 0 -off)
psset n v s *Sets power outlet n to v(value 1 -on, 0 -off) with delay s sec.
ps v    Sets all power outlets to v(value 1 -on, 0 -off)
pshow  *Displays power outlet status
p/mshow Displays power outlet timer information
punrsv n *Unreserves power outlet n from current l ogin user
rb n    *Reboots power outlet n
rbd n s *Reboots power outlet n with delay s seconds.
rbt s   *Sets reboot duration to s seconds (s > 0).
setup   Starts system configuration menu
sshshow Displays console ports config uration status
sysshow Displays system information
time    Displays current time
usershow Displays all users
whoami  Displays current login user
ver     Displays hardware and software versions
!       Repeats previous com mand
***Note - if RestrictedAccessMode is on, non -Admin users are limited
to use commands marked with "***
.
>
```

Figure 13 - Control Command Help Menu

5 USING CONFIGURATION MENU

5.1 Starting Configuration Menu:

There are four ways to start the Configuration Menu:

- 1) Local Master Port access method. Run a terminal program from a work station via serial connections between a serial port from your work station and the Local Master Port of the system.
- 2) External Modem device access method. Run a terminal program from a remote work state and establish the connection via a telephone line.
- 3) Telnet access method. Your workstation and the system are connected to LAN.
- 4) Web access method. Your workstation and the system are connected to LAN.

If you have already logged on to the system, enter the command “setup” and you will see “Main Menu” table as shown in Figure 15. Without login to the system, if you enter command “setup” you will see the following screen:

```
*****
*
*
*      *
*      *
* Login Menu      *
*      *
*      *
*      *
*****
>
> 1) Anonymous (Visitor) login
> 2) Login
> 3) Help
> 4) Quit
>Enteryourselection:
```

Figure 14 – Menu Configuration – Login Menu

Menu selection 1: When you enter the system as an anonymous user, you can start operate serial console ports or power outlets as far as they are not reserved by other users. However, you can only view system configuration parameters and are not able to make system configuration changes.

Menu selection 2: If you already have accounts established and want to start configuring the system or to change serial console port and power outlet operation status, choose this menu option.

Menu selection 3: If you do not have an account on the system or if you have an account already and want to modify your account or delete an account, select option 3.

Menu selection 4: Lists help information.

Menu selection 5: Exit menu operation.

5.2 System Main Menu:

This is a top level system main configuration menu, as shown in Figure 15 and 16.

```
*****
*
*
*      *
*      *
* Main Menu      *
*      *
*      *
*      *
*****
>
> 1) Reboot Power Outlet
> 2) Setup System
> 3) Setup TCP/IP Network
> 4) Configure Serial Console Port
> 5) Configure Power Outlet
> 6) Setup New orExistingAccounts
> 7) Reload Factory Defaults
> 8) Save Settings
> 9) Quit
>Pleaseenteryourselection :
```

Figure 15 - System Main Menu (Terminal Program Screen)

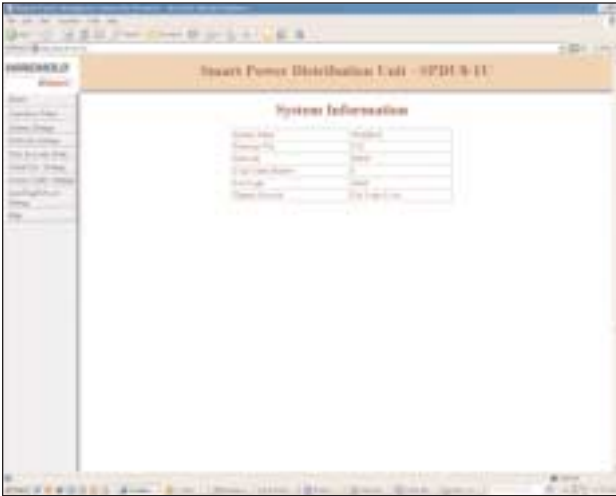

Figure 16 - System Main Menu (Web Page)

From Figure 15, System Main Menu (Terminal Screen):

Option 1 - Reboot a power outlet: Reboots a power outlet. Rebooting executes if the outlet is unreserved (“open”) or it is reserved under your account. However, if you logged in at Administration level; you are able to operate any power outlets even if they are reserved by other users.

Helpful info: control command “rb n” executes the same function as the option 1.

Option 2 – Setup System: Enters System Access Setup submenu.

Helpful info: control command “sysshow” displays system access configuration settings.

Option 3 – Setup TCP/IP Network: Enters TCP/IP Network Configuration submenu.

Helpful info: control command “nwshow” displays network connectivity information.

Option 4 – Configure Serial Console Port: Enters Serial Console Port Configuration submenu.

Helpful info: control command “sshow” displays all serial console port settings.

Option 5 – Configure Power Outlet: Enters Power Outlet Setup submenu.

Helpful info: control command “pshow” displays all power outlet current status.

control command “ptmshow” displays all power outlet timer settings.

Option 6 – Setup new or existing accounts: Enters User Account Setup submenu. Select this option if you need to create new account, change existing account, and delete existing account and reserve power outlets and serial console ports.

Helpful info: control command “userlist” displays all account names.

Option 7 – Reload Factory Defaults: Reloads to factory default settings. You must login at Administration level.

Option 8 – Save Settings: Save current system configuration parameters.

Option 9 – Quit: Returns to previous menu.

5.3 System Access Setup Menu

- **System(Device) name:** Assign a system name, sometimes referred as site or device name.
- **Date and Time:** Enter calendar date and real-time clock.

```

*****
*                                     *
*                                     *
*   System Access Setup               *
*                                     *
*                                     *
*****
>
>1) System(Device) name.....Undefined
2) Date(mm/dd/yyyy).....03/07/2007
3) Time(hh:mm:ss).....00:58:36
4) Serialportmode.....Console
5) MODEM startup string.....ATE0M0Q1&C0&DOS0=1
6) Non -Adminuserrestriction*(Y/N)..N
7) Webaccess(Y/N).....Y
8) TELNETenable(Y/N).....Y
9) TELNET timeout(max 655 35 minutes) .10
10) TELNET anonymous user(Y/N).....Y
11) Command control via email(Y/N)....N
12) SNMP agent enable(Y/N).....N
13) SNMP CommunityString.....*****
14) SNMP Trap(1 -on 0 -off).....0
15) SNMP Trap Receiver IP Address.....
s) Save.
q) Quit.
***Notefor6):forcontrollingnon -Admin user's access to system
data.
>Pleaseenteryourselection:

```

Figure 17 - System Access Setup Menu (Terminal Screen)

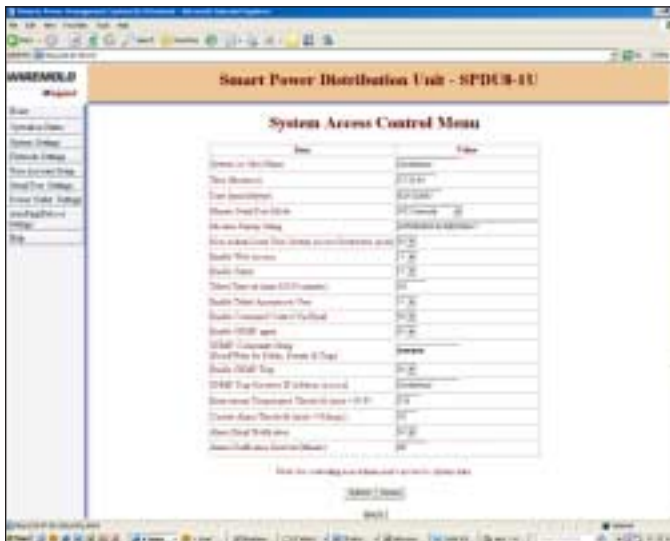

Figure 18 - System Access Control Menu (Web Page)

- **Web Access:** Enable or disable web access to the system. Default to enable.
 - **Telnet Access:** Enable or disable Telnet access to the system. Default to enable. Only one active Telnet session is permissible.
 - **Enable Telnet Anonymous User:** Enable or disable an anonymous user's access to Telnet port.
 - **Control command via Emails:** Enable or disable this access method. When it is enabled, you need to make sure you also have completed POP/SMTP server and email receiving and sending addresses. See "TCP/IP Network Configuration" setup menu for detailed information how to setup email accounts. Default to disable.
 - **SNMP Agent Enabling:** Enable or disable SNMP agent on the system. If the system SNMP Agent is enabled, it collects and stores management information and makes this information available to NMS using SNMP. Please see Section 2.5 for a list available MIB objects that the system supports. Default to disable.
 - **SNMP Trap Enabling:** Enable or disable Trap sending. If this option is enabled, Traps are sent if there is a power reboot command execution on the system. Default to disable.
- Note: You must enable the above SNMP Agent setting. Otherwise, enabling Trap setting will not take effect.**
- **SNMP Trap Receiver IP Address:** Enter Trap Monitoring receiver IP address.
 - **SNMP Community String:** To specify SNMP MIB/Trap community string. The default string is "public". This string is used for public, private and Trap.
 - **Current Alarm Threshold:** To defined AC current draw alarm threshold. The unit is Amps.
 - **Alarm Email Notification:** Enable or disable Email alarm sending method.
 - **Alarm Notification Interval (Minute):** Define alarm notification sending interval.
 - **Save and Quit:** Save current configuration data and return to previous configuration menu.

- **Serial Port Mode:** Configure the Local Master Port to interface type: either to a serial RS-232 port on your work station or an external Modem device. An external Modem device is typically equipped with a DCE (Data Communication Equipment) terminal connector. Since the system's Local Master Port and Modem device ports are not complementary, you need to use a NULL Modem cable with both male connectors. For information about connector pin assignment, please see Appendix A.
- **Modem Startup String:** Define an external Modem control command string that is sent from the system to an external modem device periodically (in every 15 minutes). If you do not need to define the control string, leave the entry field empty.

5.4 TCP/IP Network Configuration Menu:

This is a submenu of System Main Menu.

```

*****
*                               *
*   Network Configuration Menu   *
*                               *
*****
>1) Obtain IP using DHCP.....Y
2) Fallback to static IP (if DHCP failed) ..Y
3) Static IP Address.....192.168.1.100
4) Subnet Mask.....255.255.255.0
5) Gateway IP Address.....192.168.1.1
6) Set DNS Server IP Manually (Y/N).....N
7) Primary DNS IP Address.....0.0.0.0
8) Secondary DNS IP Address.....0.0.0.0
9) HTTP Port number (default 80, see note).80
10) Telnet Port Number (default 23).....23
11) POP3 Port Number (default 110).....110
12) SMTP Port Number (default 25).....25
13) POP3 Email Server.....Undefined
14) SMTP Email Ser ver.....Undefined
15) Incoming Email Account Name.....Undefined
16) Incoming Email Password.....*****
17) 2nd outgoing (replying) Email Address...
18) Outgoing Email Authentication.....Y
19) Checking Email Interval (M inutes).....2
20) Access Control List (ACL) Enable (Y/N) ..N
21) Network Connection Check Using This IP..
    [Leave blank if Gateway IP is used. Applicable to AutoPing Mode.]
e) Save.
q) Quit.
Note - Requires system reboot, if the parameter changes
Please enter your selection:
  
```

Figure 19 - Network Configuration Menu (Terminal Screen)

- **Obtain IP using DHCP:** Enable or disable DHCP. The purpose of using DHCP (*Dynamic Host Configuration Protocol*) is to assign dynamic IP addresses to a computer or a network device on a network. There must be a DHCP server on a network running and the server must permit an assigned computer or network device to be on the LAN. If this option is disabled on the NP systems, the system will not send DHCP requests to a network.
- **Fallback to static IP (if DHCP server no offer):** Define a static IP address. If DHCP is disabled on the system, there is no DHCP server running on a network, or a DHCP server refuses IP offering, you have the option to whether either allow the system to use a static IP address or not.
- **Static IP Address:** A static IP Address is an IP address that never changes. This IP address will be used if a DHCP server IP has no IP offered or DHCP automatic IP address is disabled.

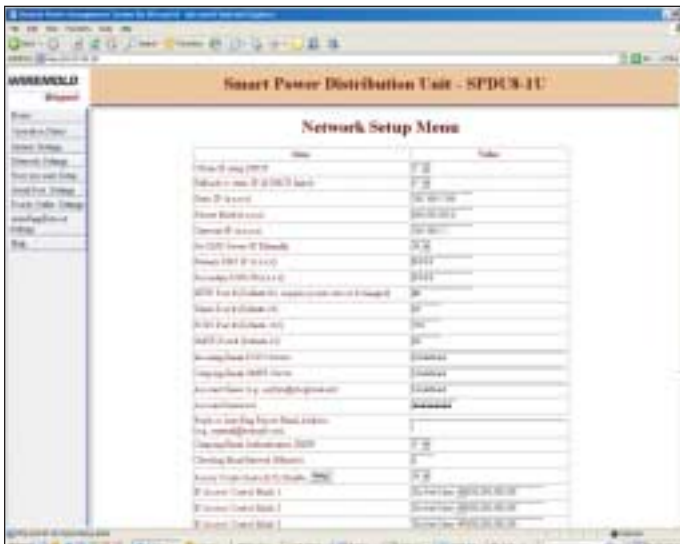

Figure 20 - TCP/IP Network Configuration Menu (Web Page)

- **Subnet Mask:** Defines a static subnet mask that is a part of your static network address settings. This entry is for your IP network class, which is distinguished by using a subnet mask.
- **Gateway IP address:** Specifies a gateway IP address that is a part of your static network address settings. This is your router's IP address.
- **HTTP Port Number:** Specifies a HTTP port number. Default value is 80.
- **Telnet Port Number:** Specifies a Telnet port number. Default value is 23.
- **POP3 Email Server:** Specifies POP (incoming Email) server address. The system supports POP3 Internet Email Protocols, not web based Email services. "mail.wiremold.com" and "pop.tom.com" are examples of POP Email servers. Make sure that the POP server you use does not require log on secure password authentication.
- **SMTP Email Server:** Specifies SMTP (outgoing Email) server address. This server will be used for you to send outgoing (reply) Emails. "mail.wiremold.com" and "smtp.tom.com" are examples of SMTP Email servers. NP supports SMTP log on secure password authentication option.

Helpful Info: Use the command "emailget" to immediately check incoming emails.

- **Incoming Email Account Name:** Specifies email address that the system receives. This email account name is also used for outgoing (replying) emails.
- **Incoming Email Account Password:** The Email account password is specified in this entry. This password is also used for outgoing (replying) emails.
- **2nd Outgoing (Replying) Email Address:** This is an additional outgoing reply email address. The system always send replying email to the sender. There is no limitation of types of destination email servers, whether a web based emailing system or SMTP. Examples of destination addresses are myMail@hotmail.com and yourMail@aol.com.

Helpful Info: Use the command "emailsend" to immediately send an outgoing test email.

- **Reply (Outgoing) Email Authentication:** If an SMTP (outgoing) email requires a user name and password authentication, enter "Y" for this entry.

Helpful Info: Use command "emailget" to immediately check incoming emails.

- **Check Email Interval:** This entry specifies how often the system checks incoming emails. The minimum interval is one minute.
- **Access Control List (ACL) Enable:** Enable or disable for controlling client IP addresses to access the system.
- **Network Connection Check Using This IP:** This entry specifies an IP address or a URL site that the NP system will ping periodically for verification of network connectivity. If the network connection is down or inactive, AutoPing is in off mode. If this entry leaves blank, network gateway IP address will be used.

5.5 More about Emailing Access:

5.5.1 Sending Control command to the system:

A control command is placed in the email subject field. It has the following format:

&SysName&userName&password&Command&,

where “&” is a command delimiter; “SystemName” is a user defined system or device name; “username” and “password” are valid user account name and password; and “command” is the actual system control command.

Command delimiters are special characters or spaces that identify the beginning or end of a group of characters in a command. Delimiters are used to separate a character string into the individual parts that form a command: command label, command name, parameter keywords, and parameter values. The default delimiter character is “&” symbol. To change it, use command “eCmd X” at terminal program or telnet session. Use command “/Help” is view available command delimiter symbols.

For example, sending email subject “&mySite3&johnW&123456&rb 2&” will reboot power outlet 2 on the NP system, named as “mySite3”. The user name is “johnW” and password is “123456”.

Before a command is executed, a confirmation reply email is sent. The destination of the replying email address is already defined in the Network Configuration Table. Figure 22 shows a reply email is received and displayed at “hotmail” web site.

A control command is not executed if the system name does not match, user name does not exists, or the name does not have the privilege to operate the designated serial console port or power outlet port, or if there is a command syntax error. If this happens, a reply email is sent to indicate the problem of the command, as shown in the Figure 23.

Helpful Info:

- Use the command “emailvbs x” to set to mail verbose mode. In verbose mode, the system displays detailed information while sending and receiving emails. It is helpful while you are setting up your email accounts.

“**emailvbs 0**” turns the verbose mode off.

“**emailvbs 1**” sets the system to level 1 verbose mode, in which high level emailing activities are displayed.

“**emailvbs 2**” sets to the system to level 2 verbose mode, in which detailed emailing activities are displayed.

- Use command “emailget” to check incoming emails immediately.
- Use command “emailsend” to send a test mail immediately.

5.6 Serial Console Port Configuration Menu:

This section describes serial console port configuration and operating settings.

Serial Console Port configuration starts with the following menu:

```
*****
*                                     *
*                                     *
*   "Master" Port Configuration Menu   *
*                                     *
*                                     *
*****
>
update.....9600
Databits: (7x8).....8
Stopbits (1or2).....1
  4) Parity (1 -Even, 2 -Odd, 3 -None).....3
  5) Flow control (1 -hardware, 2 -None).....2
name.....Master
  7) Save:
  8) Quit:
>Please select a parameter to change:
```

Figure 24 - Serial Port Parameter Entry Table



Figure 25 - Serial Port Setup Menu (Web Page)

- **Baud Rate:** The system supports the following baud rates: 2400, 4800, 9600, 19200, 38400, 57600 and 115200. It is strongly recommended that Master port and a user serial port have the same data rate while exchanging data between them so that data loss is eliminated. If you must run both ports using different baud rates, Flow Control (hardware handshaking) should be enabled on all connected serial console ports.

Please also note that when Telnet access is used for exchanging data between the system’s Ethernet interface port and user communication equipment, without enabling flow control, you might experience data loss when data exchange rate is high. This is because data flow from the system’s Ethernet port is subject to the congestion condition of LAN traffic.

- **Data Bit:** Supports 7 or 8 bits.
- **Stop Bits:** Supports 1 or 2 bits.
- **Parity Bits:** Supports Even, Odd or None.
- **Flow Control:** Flow Control is hardware handshaking using CTS/RTS signals on the connectors. Please see Appendix A for information about RS232 connector pin assignments.
- **Port Name:** Assign a name for the port. Always assigned to the name “Master”.

5.7 Power Outlet Setup Menu:

This section describes:

- 1) Manual Power Outlet Set Switch Operation.
- 2) Power Outlet Configuration
- 3) AutoPing Functions
- 4) Timer Usages.

Manual Power Outlet Set Switch Operation:

- 1) Press the switch for more than 0.5 seconds (but less than 3 seconds) and then release the switch. You will see a LED on the front panel blinking. Continue the procedure until the desired LED/power outlet number is selected.
- 2) Once the desired LED (power outlet number) is blinking, holding down the switch for 3 seconds. Then you will observe the LED is changed to solid On or Off state. The power outlet power status is changed accordingly.
- 3) Repeat the procedure 1) and 2) for change the next power outlet state.

If you run a terminal program, power outlet setup starts with the following menu:



Figure 26 - Power Outlet Setup Menu (Terminal Screen)

- **Change Power Port Parameters:** Enter power outlet configuration submenu.
- **Change Power Reboot Duration:** Enter power reboot duration value. When the reboot process starts, the system flips current power outlet status from On to Off, or Off to On for the number of seconds that this parameter defines. The default value is 5 seconds. This is parameter applies to all power outlets.
- **List of All Power Port Status:** Display all power ports current statuses, as shown in Figure 30.

Helpful Info: Use command “pshow” to display all power outlet status.

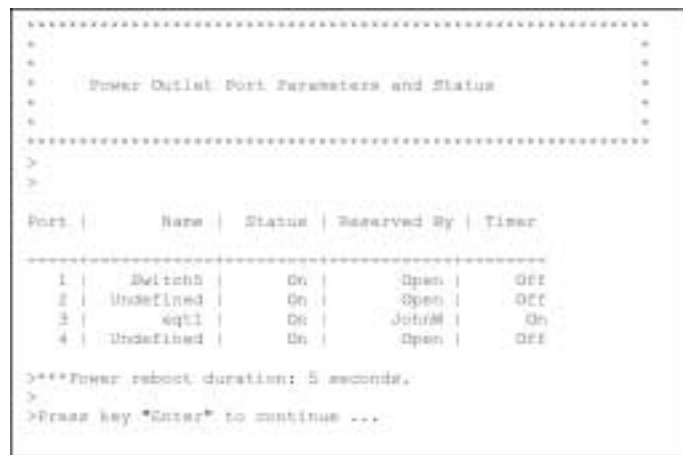

Figure 27 - List of Power Outlet Status (Terminal Screen)

Figure 28 and 29 show the power outlet entry table. This is an example of the power outlet in Timer off mode. In Figure 29, to enable the Timer, select option 3. Once a timer is enabled, the entry table is extended including all timer parameters as shown in Figure 33.

```

Power Port 2 Configuration Menu
-----
Current Time: 3:13:43, Date: 7/4/1998
1) Power Outlet name.....Undefined
2) Power Port[1-On] 0-Off[.....]
3) Power Outlet timer[1-On] 0-Off[.....]
4) Enable AutoPing[Reboot if Network down](Y/N)..N
5) Max Network Down Time(seconds) Allowed.....60
6) AutoPing destination IP address(or URL).....
7) Save:
8) Quit:

```

Figure 28 - Power Outlet Setup Menu (Web Page)

```

Power Port 2 Configuration Menu
-----
Current Time: 3:13:43, Date: 7/4/1998
1) Power Outlet name.....Undefined
2) Power Port[1-On] 0-Off[.....]
3) Power Outlet timer[1-On] 0-Off[.....]
4) Enable AutoPing[Reboot if Network down](Y/N)..N
5) Max Network Down Time(seconds) Allowed.....60
6) AutoPing destination IP address(or URL).....
7) Save:
8) Quit:

```

Figure 29 - Power Outlet Parameter Menu (Timer Off Mode)

```

Power Port 2 Configuration Menu
-----
Current Time: 3:14:18, Date: 7/4/1998
1) Power Outlet name.....Undefined
2) Power Port[1-On] 0-Off[.....]
3) Power Outlet timer[1-On] 0-Off[.....]
4) Enable AutoPing[Reboot if Network down](Y/N)..N
5) Max Network Down Time(seconds) Allowed.....60
6) AutoPing destination IP address(or URL).....
7) Timer Start Time (month/day/hour:minute).....07/04/03:14:08
8) Timer Period (day/hour:minute).....00:04:00:30
9) Timer Loop Count (0 - infinite).....1685
10) Timer Toggle Duration.....5
11) Help:
12) Save:
13) Quit:
Please select a parameter to change:

```

Figure 30 - Power Outlet Parameter Menu (Timer On Mode)

- **Power Outlet Name:** Define a name for the power outlet.
- **Power Outlet:** Set the power outlet to power on or off state.
- **Power Outlet Timer:** Enable or disable the Timer for the port.
- **Enable AutoPing (Power reboot if user equipment's network is down):** Disable or enable AutoPing power reboot function. If it is enabled, the system schedules auto pings to the communication equipment that is connected to the power outlet. If no response is received in a period of time (user defined, see below) from the communication equipment, the system starts the power reboot process for the power outlet.

Helpful Info: Use the command *"/apVbs 1"* to displays AutoPing run-time information.

- **Max Network Downtime allowed:** Set a value of maximum network down time, in seconds. If probed communication equipment does not send ping response messages back to the system for this period of time, the system will start reboot processes for the power outlet.

Note: AutoPing starts power reboot process if and only if the following two conditions are met:

- 1) NPC system is active on the network interface. This enables AutoPing mode at system operation level.

The active network connection is verified periodically by pinging a network target IP address (default to network gateways IP address). If there is no response from the network target address, AutoPing mode is in off mode.

- 2) Once AutoPing mode is on, if user communication equipment stops sending responses back to the NPC system for a period of time (Max Network Downtime allowed), power rebooting process begins. If the user equipment has never sent a ping response back to the system after AutoPing mode turns on, AutoPing will never trigger the power reboot process for the power outlet.

- **AutoPing (Ping) destination IP address (or URL):** Enter an IP address of the probed communication equipment IP. This IP address is associated to the power outlet.

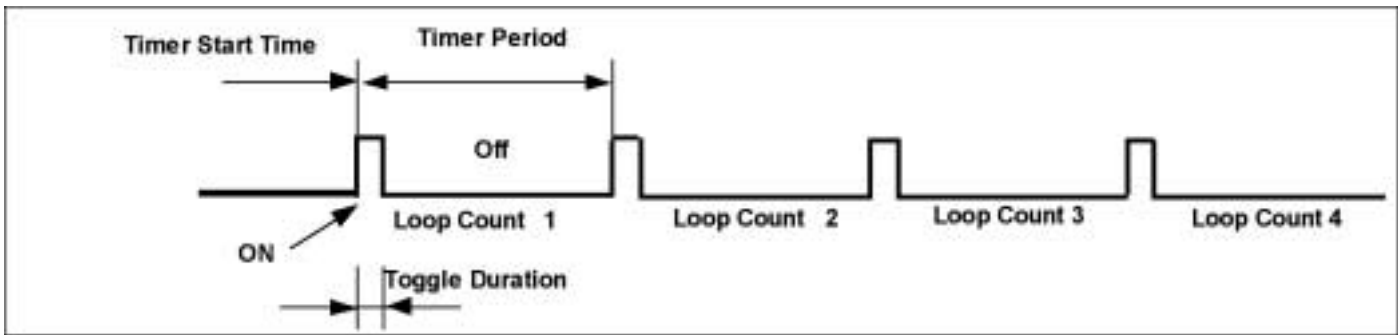

Figure 30 - Power Outlet Parameter Menu (Timer On Mode)

- **Timer Start Time:** Specify starting time for the timer. The starting time is the actual calendar date and real-time clock. Once a timer reaches this specified Start Time, the power outlet on/off state will flip. It is in the format of “month:day:hour:minute:second”. For example, to start changing the power outlet on/off state at 6:31:2pm, on June 20th, the entry data is 6:20:18:31:02.
- **Timer Period:** Specify the timer period. It is in the format of “days:hours:minutes:seconds”, which is not a calendar and real-time clock entry type. The period setting is used for applications that require the power outlet to continuously change on/off in a specific interval. For example, you need to schedule power reboot for the outlet daily, the period is 24 hours. Your entry will be 00:24:00:00.
- **Timer Loop Count:** The number of Periods for the Timer is defined as Loop Count. For example, you schedule the timer to flip the power outlet states in every 20 seconds and want to repeat 300 times, your entry will be 300.

Enter “0” for this setting, if you schedule the power outlet simply change power state from on to off, or from off to on a specific time and date.

Enter “1” for the setting, if you schedule the power outlet to be on-off-on, or off-on-off once. For example, the system executes one power reboot cycle on a specific date and time.

- **Toggle Duration:** Specify the duration of the power outlet state that toggles when a new Timer Period starts. This parameter is meaningful if the Timer Loop Count is > 0. The unit for the duration is in seconds. The concept of the specification can also be viewed as Duty Cycle. The value of this parameter should be $0 < \text{Toggle Duration} < \text{Timer Period}$.

There are a few examples of applications using the Power Outlet Timers:

- 1) **Reboot daily:** Current Calendar date and time are:
Aug. 10th, 10:00 am.

Requires daily power Reboot at 1:00am.
Reboot duration is 10 seconds.

Timer Start Time = 8:11:1:0:0
Reboot starts on Aug. 11th, 1:00 am.

Timer Period = 1:0:0:0
Period is 1 day, 0 hour, 0 minute, and 0 second.

Timer Toggle Duration = 10
Power outlet will toggle on/off state for 10 seconds.

Timer Loop Count = 1000
1000 days

- 2) **Toggle Power Outlets for 300 times:** Toggling Power outlet on/off state 300 times in a period of 10 seconds starts immediately.

Current Calendar date and time are:
Aug. 10th, 10:00 am.

Timer Start Time = 8:10:10:00:20
Start toggling on Aug. 10th, at 10:00:20 am.

Timer Period = 20
Choose 20 seconds and duty cycle 50%.

Note: the period setting is not 10.

Timer Toggle Duration = 10
This results in 10 seconds on and 10 seconds off.

Timer Loop Count = 300
300 periods.

- 3) **Reboot once on a specific date and time:**

Current Calendar date and time are:
Aug. 10th, 10:00 am.

To schedule a reboot on Feb 12th, 1:00 am.

Timer Start Time = 2:12:1:00:00
Start the event at 1:00am, on Feb. 12th

Timer Period = 6
6 seconds

Timer Toggle Duration = 5
5 seconds.
Reboot duration is 5 seconds.

Timer Loop Count = 1
Reboot once.

APPENDIX A LIMITED WARRANTY & LIABILITY STATEMENT

Wiremold/Legrand warrants, to the original purchaser or owner only, that any product manufactured and sold by Wiremold/Legrand will be substantially free from defects in material and workmanship under normal use and service, for a period of one year from the date of original installation or two years from the date of purchase, whichever is sooner. This limited warranty applies only to products, which have been installed properly in accordance with Installation Instructions supplied by Wiremold/Legrand and any applicable codes and standards.

This limited warranty is void and Wiremold/Legrand shall not be liable for any damages or held responsible for the quality, performance or safety of products that have been repaired, altered or tampered with outside of Wiremold/Legrand facilities or which have been intermixed (used within a system) with products or materials not approved by Wiremold/Legrand or have been subjected to accident, negligence, misuse or abuse.

Wiremold/Legrand's sole obligation (and the sole and exclusive remedy of the purchaser or owner of the product) with respect to any products which are proven to be defective, shall be the repair or replacement of the defective products, at the sole

option of Wiremold/Legrand. Returned products will not be accepted unless The Wiremold Company is notified and authorizes the return, prior to shipment.

Wiremold/Legrand shall not be liable for any damages in excess of the purchase price of the defective products, and under no circumstances shall Wiremold/Legrand be liable for incidental, consequential, special or punitive damages.

Certain products of Wiremold/Legrand may have a specific limited warranty or limitation of liability which is included with such products and which differs from that set forth in this Statement. The terms of any such specific limited warranty or limitation of liability will supersede that set forth in this Statement.

Except as set forth in the preceding paragraph, THIS LIMITED WARRANTY IS EXCLUSIVE AND Wiremold/Legrand MAKES NO OTHER WARRANTIES WITH RESPECT OF ITS PRODUCTS, EXPRESSED OR IMPLIED, INCLUDING NO WARRANTY OF MERCHANTABILITY OR OF FITNESS FOR A PARTICULAR PURPOSE.



APPENDIX B SERIAL CONSOLE PORT INTERFACES

PIN #	NAME	LONG NAME	DIRECTION	DESCRIPTION
1	DCD	Data Carrier Detect	<<<	Raised when an carrier communication is established.
2	TD	Transmitting Data	>>>	Serial data stream sent to the DTE device. Same note as above apply.
3	RD	Receive Data	<<<	Receives serial data stream.
4	DSR	Open	<<<	Not connected.
5	GND	Signal Ground		
6	DTR	Terminal Ready	>>>	Indication of serial port activated.
7	CTS	Clear To Send	<<<	When hardware flow control is enabled, if this signal is raised, an external device can send data to Local Master Port.
8	RTS	Request To Send	>>>	When hardware flow control is enabled, this signal is raised by the Local Master Port when it is ready to receive new data from an external device.
9	Open	Open		
6	Open		<<<	Not connected.
8	CTS	Clear To Send	<<<	When hardware flow control is enabled, if this signal is raised, an external device can send data to Local Master Port.
7	RTS	Request To Send	>>>	When hardware flow control is enabled, this signal is raised by the Local Master Port when it is ready to receive new data from an external device.
9	Open			Open

APPENDIX C RS-232 TO RJ45 CONVERSION CABLES

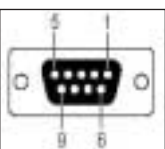

RS-232 — RJ45 (8-PIN)

C-RJ45-DB9F-4, RJ-45 to RS232 (Female, DCE) cable, 4'

RS-232 — DB9 FEMALE		 DB-9 F	RJ45 (8-PIN)	
PIN #	SIGNAL		PIN #	SIGNAL
1	DCD	 8	1	DSR
2	TxD		2	RTS
3	RxD		3	GND
4	DSR		4	TxD
5	GND		5	RxD
6	DTR		6	DCD
7	CTS		7	CTS
8	RTS		8	DTR
9	-			

RS-232 — RJ45 (8-PIN)

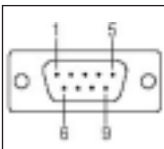
C-RJ45-DB9M-4, RJ-45 to RS232 (Male, DTE) cable, 4'

RS-232 — DB9 MALE		 DB-9 M	RJ45 (8-PIN)	
PIN #	SIGNAL		PIN #	SIGNAL
1	DCD	 8	1	DSR
2	RxD		2	RTS
3	TxD		3	GND
4	DTR		4	TxD
5	GND		5	RxD
6	DSR		6	DCD
7	RTS		7	CTS
8	CTS		8	DTR
9	-			